

# NEA SMYRNI 2

nr. 48 MYKALIS str.

FACADE FROM MYKALIS str

Apartment

**D.2**

50,50 m<sup>2</sup>

1st floor



# NEA SMYRNI 2

nr. 48 MYKALIS str.

1st FLOOR

Apartment

## D.2

50,50 m<sup>2</sup>

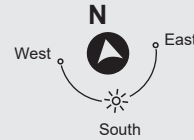

Mykalis str.

Characteristics	
Bedroom	1
Bath	1
Total Aeria	50,50 m <sup>2</sup>
Balcony (total)	19,00 m <sup>2</sup>
Parking spot	P.8
Home storage	N° 4 = 7,73 m <sup>2</sup>

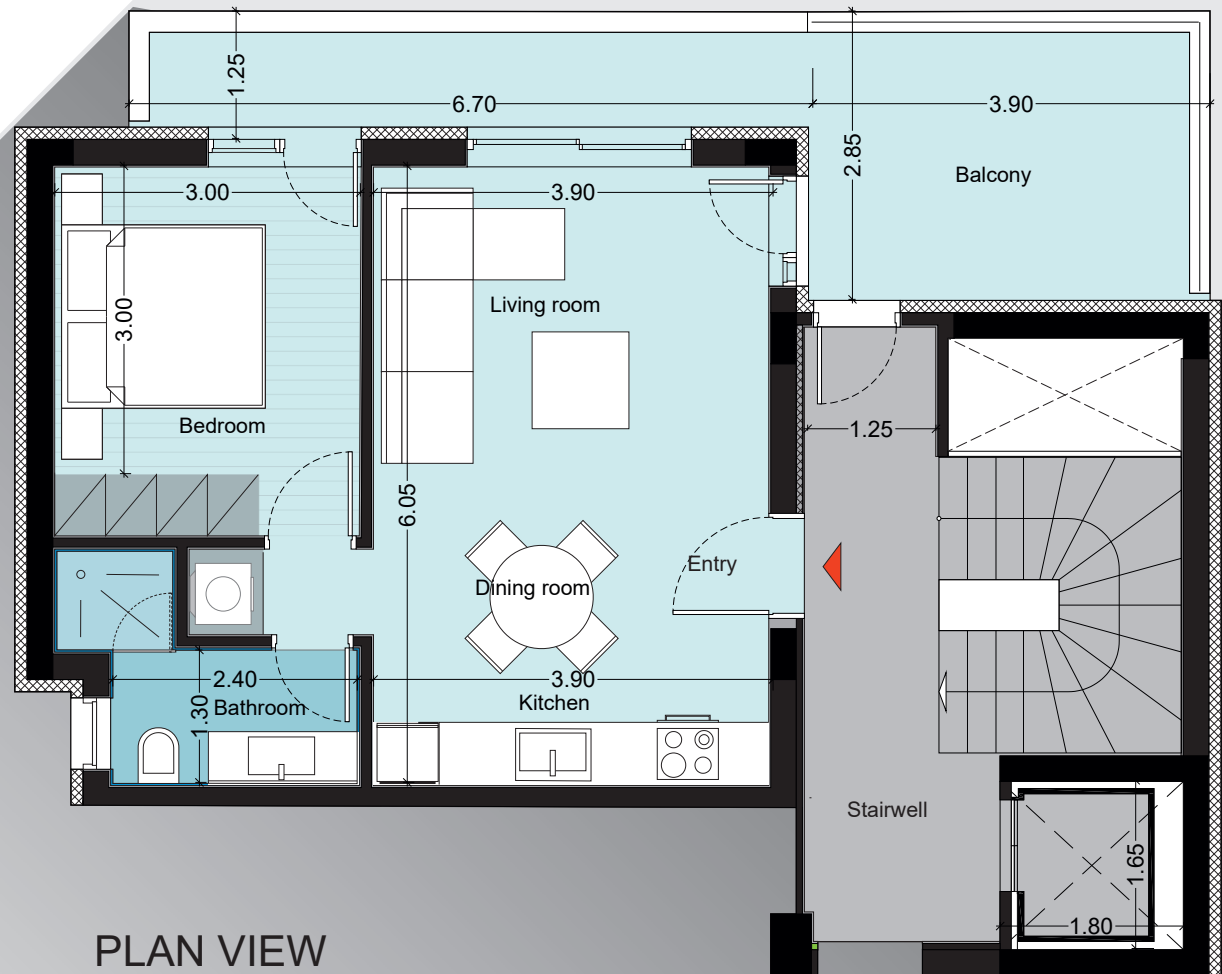

PLAN VIEW

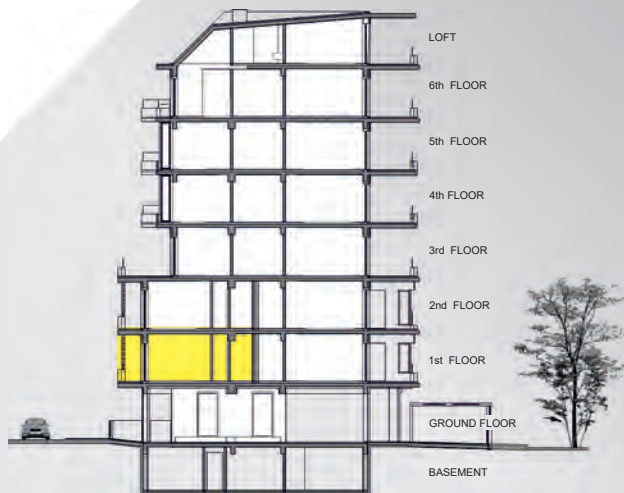

# NEA SMYRNI 2

nr. 48 MYKALIS str.

GROUND FLOOR

Apartment

## D.2

50,50 m<sup>2</sup>

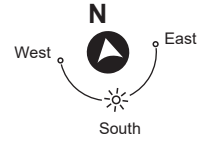

Characteristics	
Bedroom	1
Bath	1
Total Aeria	50,50 m <sup>2</sup>
Balcony (total)	19,00 m <sup>2</sup>
Parking spot	P.8
Home storage	N° 4 = 7,73 m <sup>2</sup>

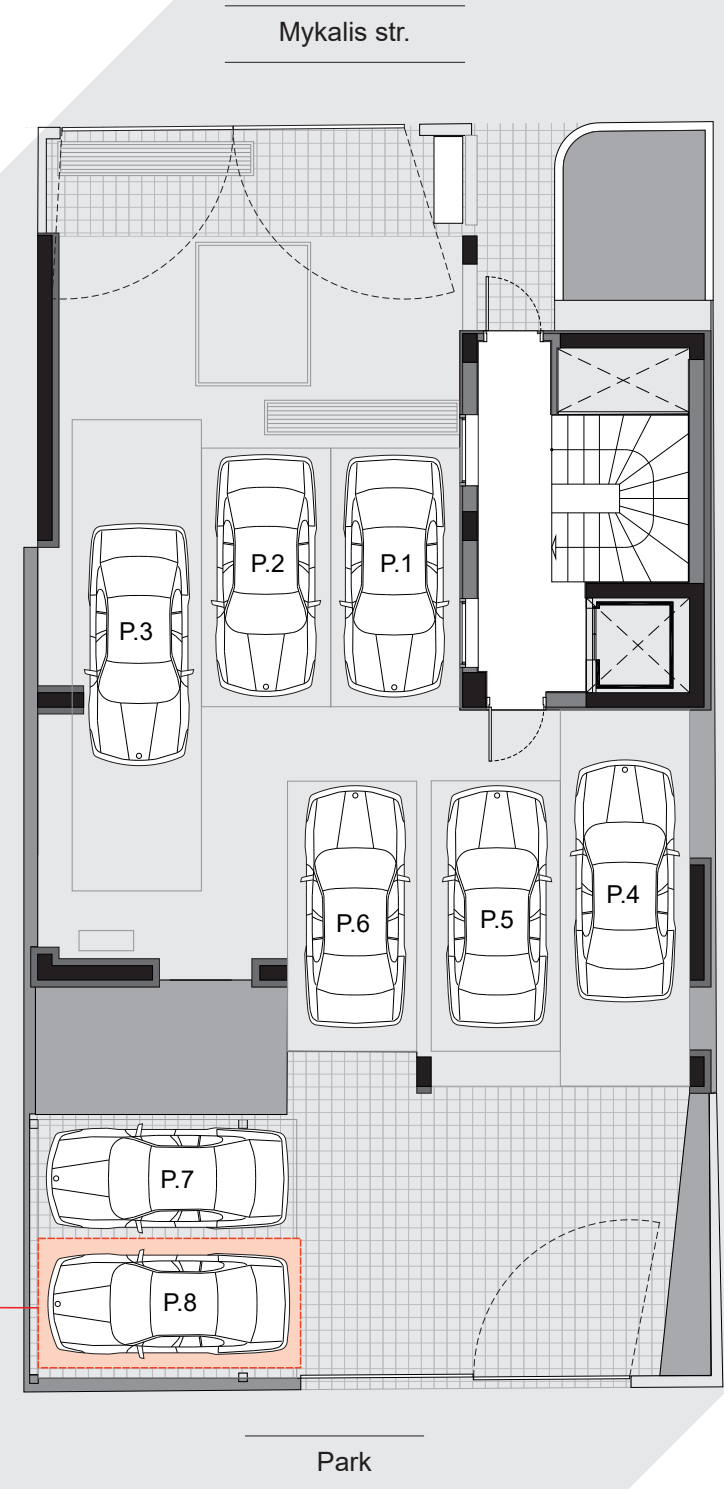
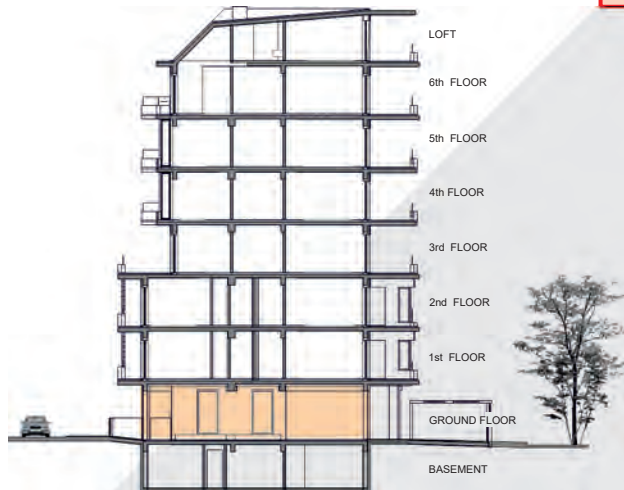
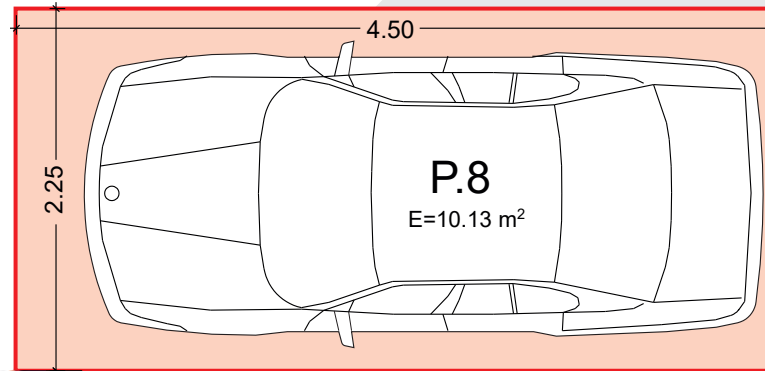

# NEA SMYRNI 2

nr. 48 MYKALIS str.

BASEMENT

Apartment

## D.2

50,50 m<sup>2</sup>

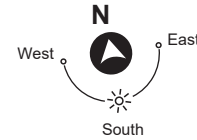

Characteristics	
Bedroom	1
Bath	1
Total Aeria	50,50 m <sup>2</sup>
Balcony (total)	19,00 m <sup>2</sup>
Parking spot	P.8
Home storage	N° 4 = 7,73 m <sup>2</sup>

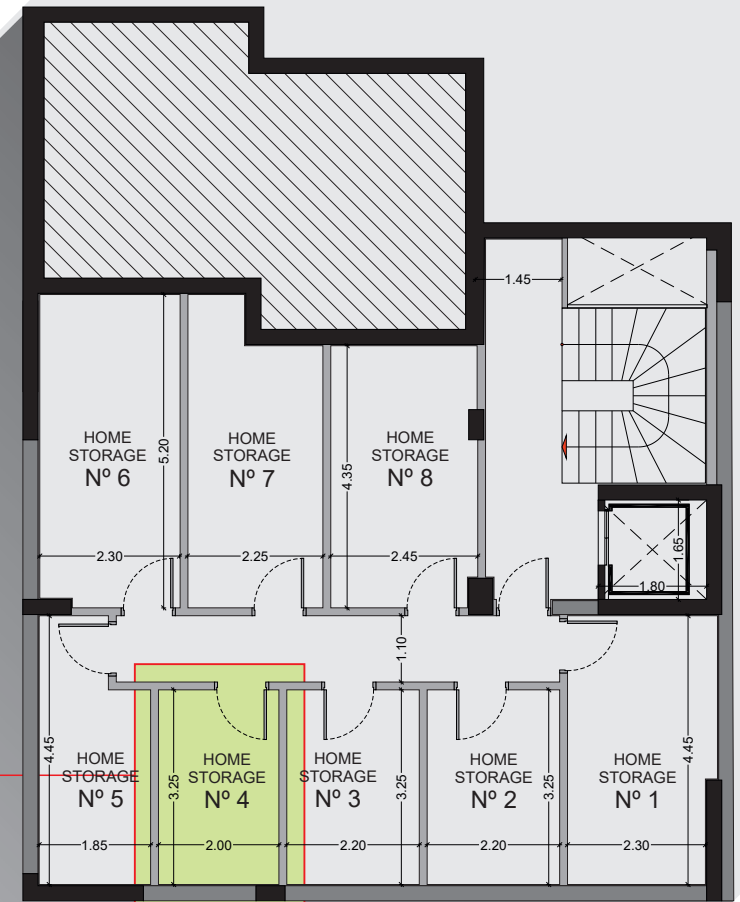
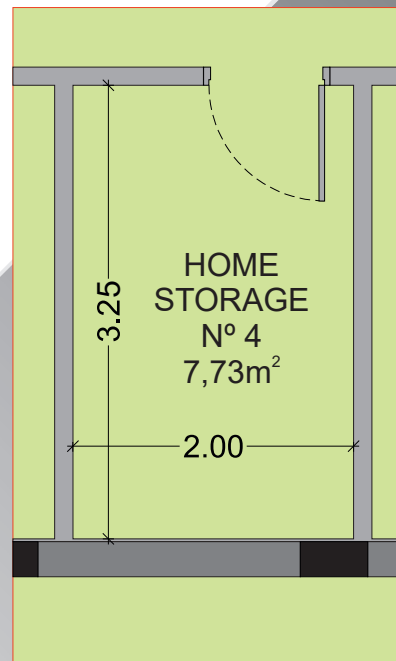

BASEMENT

